



START DIODE TIME WALK COMPENSATION

C. J. MOORE

J. VEAR

J. POONPOL

Introduction

While much attention has been given to the accuracy of the time that received photons are detected, much less has been given to the timing accuracy of the transmitted laser pulse: the accuracy of SLR measurements depends on both. This is partly due to the fact that transmitted pulse shape and energy should be very stable and the response of, typically, a photodiode start detector, should be very repeatable from shot to shot. However since constant level discriminators are often used for defining the timing start event, there is potential for time walk to occur between shots if the transmitted laser pulse amplitude is subject to significant variations.

While all means to maintain constant laser pulse energy are taken, short and medium term fluctuations can occur. This paper describes a method to compensate for resulting time walk should transmitted laser pulse energy vary over time for whatever reason.

A relatively simple peak voltage monitor was developed to measure the peak amplitude of each start detector output pulse, which for Mt Stromlo SLR station occurs at 60Hz. The data from this monitor is added to the ranging data stream and included in post processing of both system delay calibrations and satellite range measurements.

Test results described in this paper indicate that excursions in the order of 1-2 mm resulting from laser beam variations can be successfully compensated using this technique.

PEAK VOLTAGE MONITOR

To obtain a measure of the response of the start diode timing unit to an incident laser pulse, a peak voltage monitor (PVM) was constructed and connected to the buffered output of start diode timing unit. This PVM incorporates a CAN bus interface connected to the LAN, such that measured data values are "published" to software servers running on PCs connected to the LAN. This allows peak voltage of each or selected pulses from the output of the start diode timing unit to be captured and sent to a streaming plot display or to be saved in the ranging system binary range data (BRD) files for subsequent post-processing.

A simplified circuit of the PVM is shown in Figure 1.

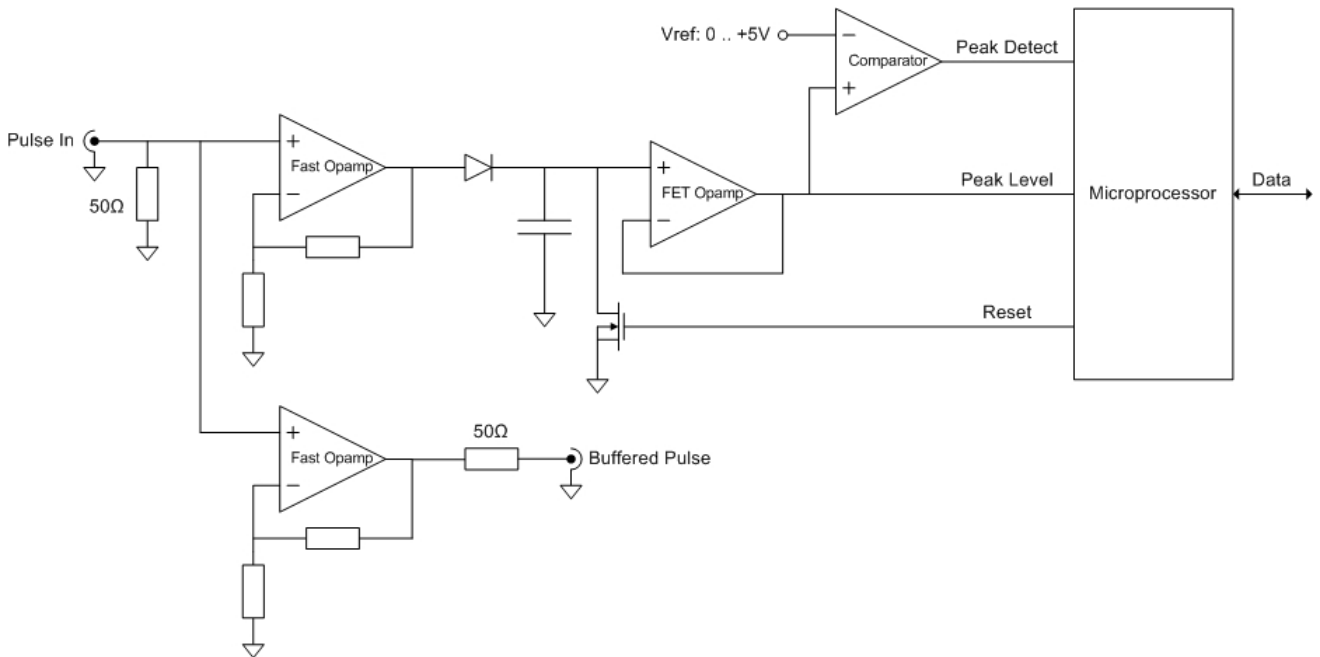

Figure 1: Peak Voltage Monitor circuit.

PEAK VOLTAGE MODEL CALIBRATION

In order to develop a method of time walk compensation, it is necessary to calibrate the start diode timing unit and thus determine the relationship between peak voltage and time walk in a controlled way. The minimum voltage that could be monitored by the PVM was approximately 0.4V, and the intensity could only be varied by a factor of 2, hence the operating range of the start diode timing unit was modified to support at least 0.4 V and to operate normally above 0.8V. The optical filter on the input to the start diode unit was modified to give an operating voltage of 0.85V.

Calibration pier measurements were then taken at various intensities of the laser beam incident on the start diode while holding the output laser signal and

other common factors constant. This was accomplished by introducing various optical filters in front of the start diode aperture. This technique also introduces an effective delay shift in the system calibration data since the optical filters (of some finite thickness) are not placed in the common optical path of the output laser beam. Hence a delay correction of $\delta t = \frac{(n-1)d}{c}$ must be added to system delay values where n is the filter refractive index, d is its thickness and c is the speed of light. The following filters were used;

Table 1: Optical filters used for attenuating the incident laser beam

ND	Refractive Index	Thickness (mm)	Correction (ps)
0.3	1.52	1.56	2.71
0.1	1.50	1.27	2.11

The plot in figure 2 shows the results of two sets of measurements, taken at 60Hz, of system delay (plus correction) against PVM readings averaged over periods of 5 minutes or greater.

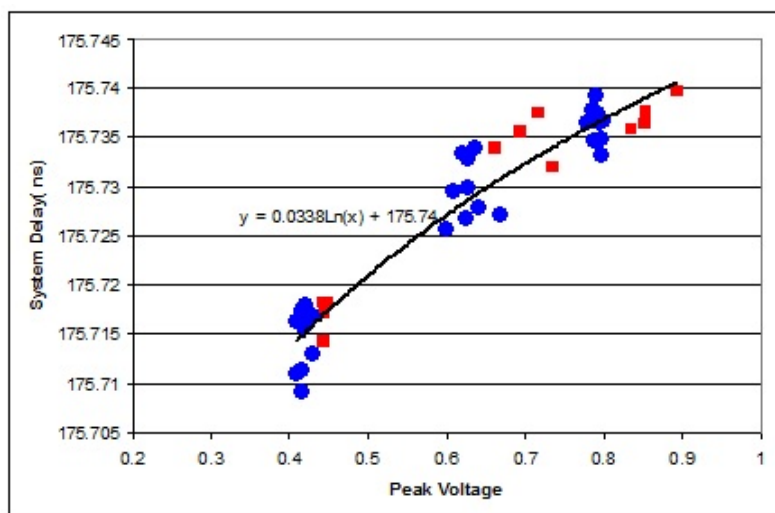

Figure 2: Combined measurements.

While there is no *a priori* reason for assuming any particular relationship between peak voltage and time shift, it appears a logarithmic relationship fits the available data quite well and may very well be related to exponential photodiode responses. In any case we let

$$s - s_{ref} = \delta s = k \ln\left(\frac{V}{V_{ref}}\right) \quad (1)$$

where s is the system delay at a given laser beam intensity, and V is the peak voltage at that intensity. s_{ref} is the system delay at a selected reference voltage V_{ref} . We consider δs to be the system delay time walk compensation. The reference voltage, V_{ref} , should be chosen to be equal to the nominal operating voltage (in our case about 0.85V). Normal operating voltage will be dependant on the laser beam and start diode timing unit configuration, but recovery close to this nominal value should be attempted. Our calibration indicated that k was approximately 0.034 ns.

Typical short term peak voltage measurements (with no attenuation), similar to figure 3, indicates that we have RMS values of around 30mV and peak to peak variations of up to 200mV. This suggests short term time walk values may be up to 10ps (or 1.5 mm in range measurement). Longer term variations (due to laser beam fluctuations etc) may exceed these values, but this time walk model can be used to compensate for such variations.

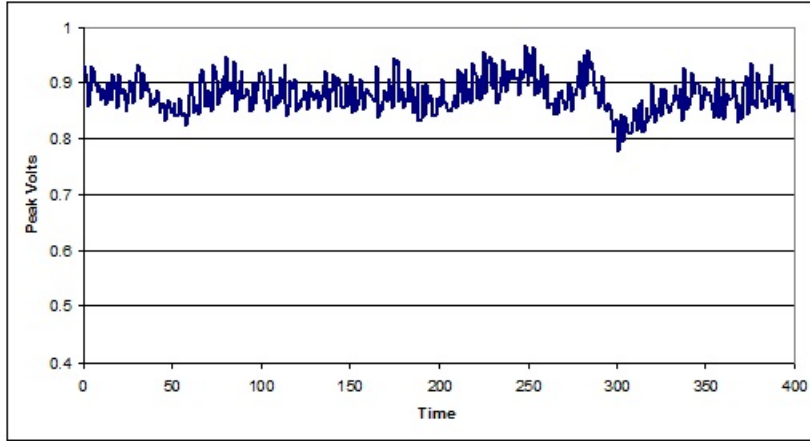

Figure 3: A typical time series of start diode peak voltage measurements.

SYSTEM DELAY COMPENSATION

Start diode time walk will affect measurements of both system delay and target range. Given that the measurements of target range use measurements of system delay (generally taken just before and just after a range measurement) it is therefore necessary to take into account time walk compensation in both sets of measurements.

Assume for the moment that the laser input to the start diode is ideal and the peak voltage is equal to V_{ref} , we can then simply use one measurement of system delay to apply to the range measurement. The measured system delay is clearly s_{ref} and the actual range, R_i , is therefore given by $R_i = T_i - s_{ref}$ where T_i is the raw or total range measurement. Here for simplicity we neglect other factors influencing path propagation time such as refraction, window delays etc.

If the pulse voltage is not ideal, then R_i will be subject to a time walk error. But the use of s_{ref} is still necessary from separate measurements of system delay; it is s_{ref} that must be determined from time to time and be available for range measurements.

During a calibration pier run, raw or total range measurements, T_i are obtained. These allow the system delay at each moment to be estimated (neglecting other factors) from

$$s_i = T_i - P$$

but

$$(s_{ref})_i = (T_{compensated})_i - P$$

hence

$$(T_{compensated})_i = T_i - \delta s_i$$

Here P is the predicted range which we will treat as a constant derived from survey data. At Mt Stromlo, measurements from calibration pier targets are processed in a similar way to target range data, and a nominal system delay, s_{nom} is applied to raw measurements to form residuals, r_i which are subsequently filtered and analysed. Thus we have

$$r_i = (T_{compensated})_i - s_{nom} - P$$

or

$$r_i = T_i - P - (s_{nom} + \delta s_i)$$

Hence the mean value of the required system delay, s_{ref} can be derived from the mean value of the residuals, or

$$s_{ref} = \bar{r}_i + s_{nom} \quad (2)$$

These values are saved in a system calibration database for application to range measurements.

RANGE COMPENSATION

During a target range session, raw or total measurements T_i are taken. These data must be adjusted for concurrent system delay using values obtained before or after the session, adjusted for any time walk compensation experienced during this session. Similar to calibration pier data, we can say that a compensated range value using the currently measured peak voltage be given by

$$T_i - (T_{compensated})_i = \delta s_i = k \ln\left(\frac{V_i}{V_{ref}}\right)$$

and that residuals generated from these data (ignoring other factors) are given by

$$r_i = (T_{compensated})_i - s_{ref} - P_i$$

where P_i here is the predicted range obtained from target ephemerides. These residuals are filtered and analysed to generate full rate, normal point and other SLR products. Hence these residuals can therefore be derived from raw measurements less the time walk compensation factor, or

$$r_i = T_i - P_i - (s_{ref} + \delta s_i) \quad (3)$$

and s_{ref} , obtained from the system calibration database is the appropriate system delay to apply.

TEST RESULTS

SLR operations at Mt Stromlo operate with two active software servers which collect ranging and other data and at the end of each ranging task, save the data in binary range data (BRD) files. These files are the source of data for all subsequent post-processing. During June 2014, one of the servers was modified to capture PVM data and save in the BRD files along with the usual ranging data, and the post processing software was modified to support the calculations and application of time walk compensation. These modifications include display of time walk corrections for each range measurement such as that shown in figure 4 for a typical pier calibration session.

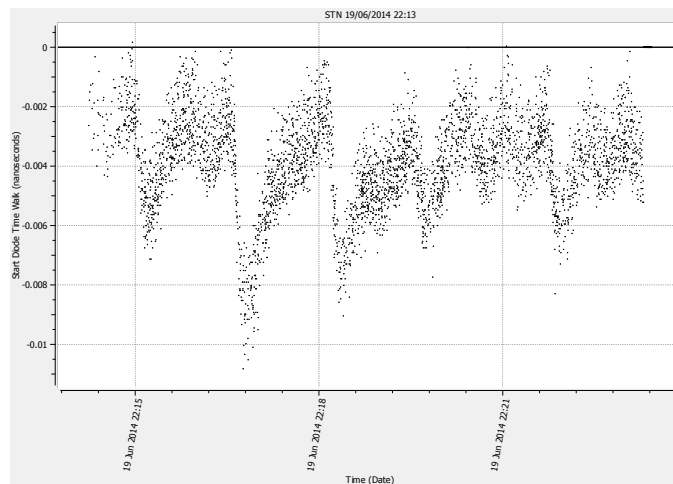

Figure 4: Time series of time walk compensation values during a pier (STN) calibration session.

Data from the two sets of BRD files was used to compare compensated and uncompensated system delay values. The results for data collected over about one month as shown in figure 5, illustrate the effect changing the start diode optical filter on the 13th June, and readjustment and realignment of the regen laser on 24-25th June.

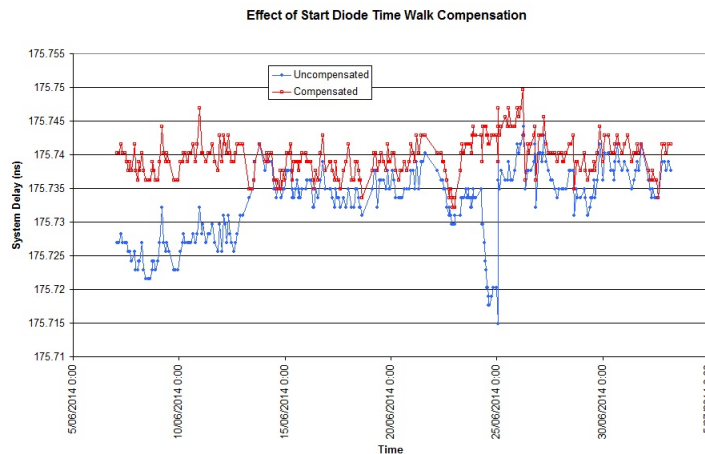

Figure 5: Time series of system delay values, one corrected for start diode amplitude and the other uncorrected.

An assessment of the variability of system delay values (averaged over each calibration pier session) over the test period was made by applying N-point moving average and associated standard deviation to the compensated and uncompensated data. The results of a 16 point assessment, shown in figure 6, indicate that compensation makes little difference for most of the time, but when there are significant excursions in incident pulse energy, compensated system delay values are consistent with normal energy levels.

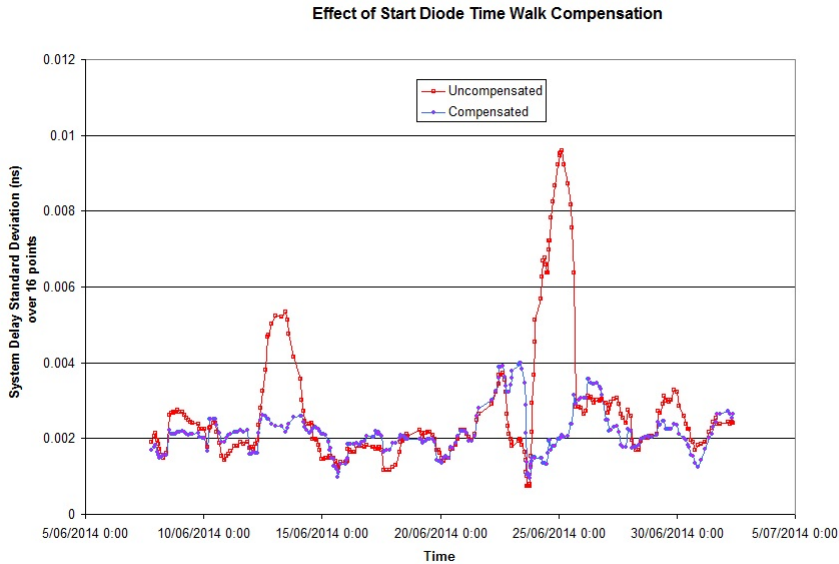

Figure 6: Standard deviation of system delay values for a 16 point moving average for compensated and uncompensated data.

To investigate the amplitude excursions noted in figure 4, a two-hour cal pier session was run during which PVM data, SLR table air temperature and humidity were logged and laser chiller temperature data, as displayed on the front panel, were monitored. The air temperature and humidity were very stable and no correlations were found. However, as shown in Figure 7 a plot of start diode PVM data overlaid by regen chiller temperature observations does show a definite correlation with chiller temperatures even though these data have a resolution of 0.1 °C, and vary between 23.7 and 24.1 °C. Inspection of the amplitude variations suggest there is an underlying cycle of approximately 40 seconds with larger excursions occurring every 2, 3 or 4 cycles.

These data indicate that the coupling of laser pump head cooling water temperature and energy of laser pulses from the regen may be significant over the short term, and contribute to increased range data single shot RMS if start diode time walk compensation is not applied.

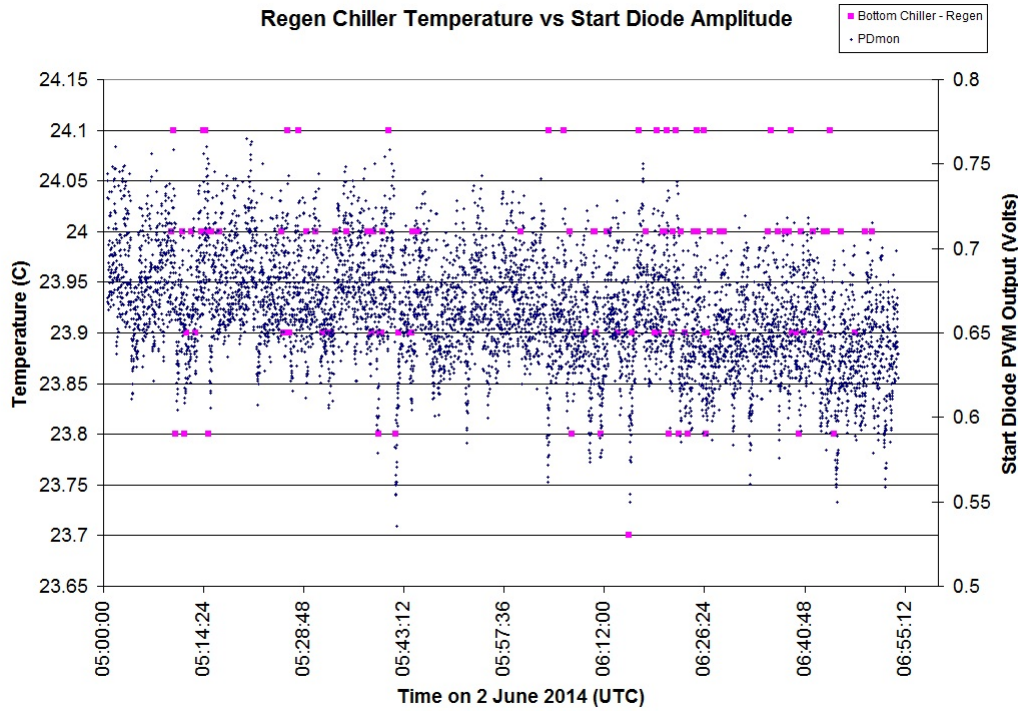

Figure 7: Start diode amplitude data (from PVM output) and observations of regen chiller (front panel) temperature taken over a two hour period.

CONCLUSIONS

From figure 5 it is clear that there are significant short term variations or excursions in the start diode amplitude occurring during ranging sessions, of magnitudes up to 10ps (1.5mm). Such variations must contribute to both system delay measurements but more significantly to single shot range measurements. In addition there are also slower trends observed in the data during each session and between sessions that will introduce errors due to system delay measurements being taken at different times to range measurements. It is clear that the application of start diode time walk compensation is therefore warranted and is now very easily implemented. Such compensation will be most significant where there are long term amplitude variations (as observed in figure 5) and when there are medium term trends as observed in figure 4.

However it should be noted that while the amplitude of the start diode is relatively stable, short term variations of system delay measurements are not significantly improved by start diode time walk compensation as illustrated in figure 5, where variations in system delay are presumably caused by other factors. In both cases, the error in system delay is generally around 2 - 2.5 ps (0.3 - 0.4 mm). Application of the start diode time walk compensation will help to maintain this level of accuracy during periods when the amplitude is not so stable.