

Concept

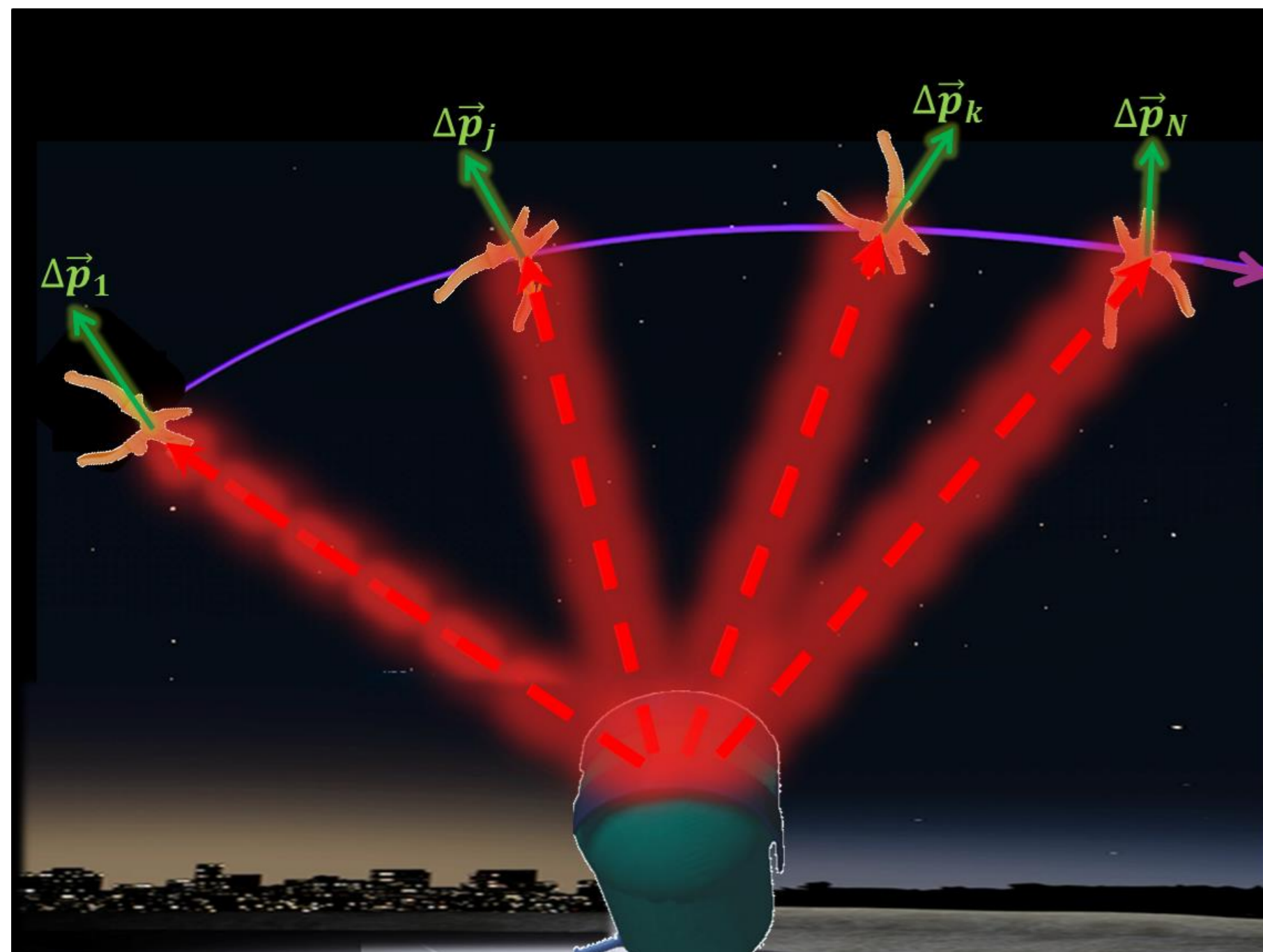

- Surface ablation by laser pulses
→ Recoil on debris target
→ Perigee lowering
→ Burn-up in atmosphere
- Targeted debris size: 1...10 cm

Ablative Recoil Measurements

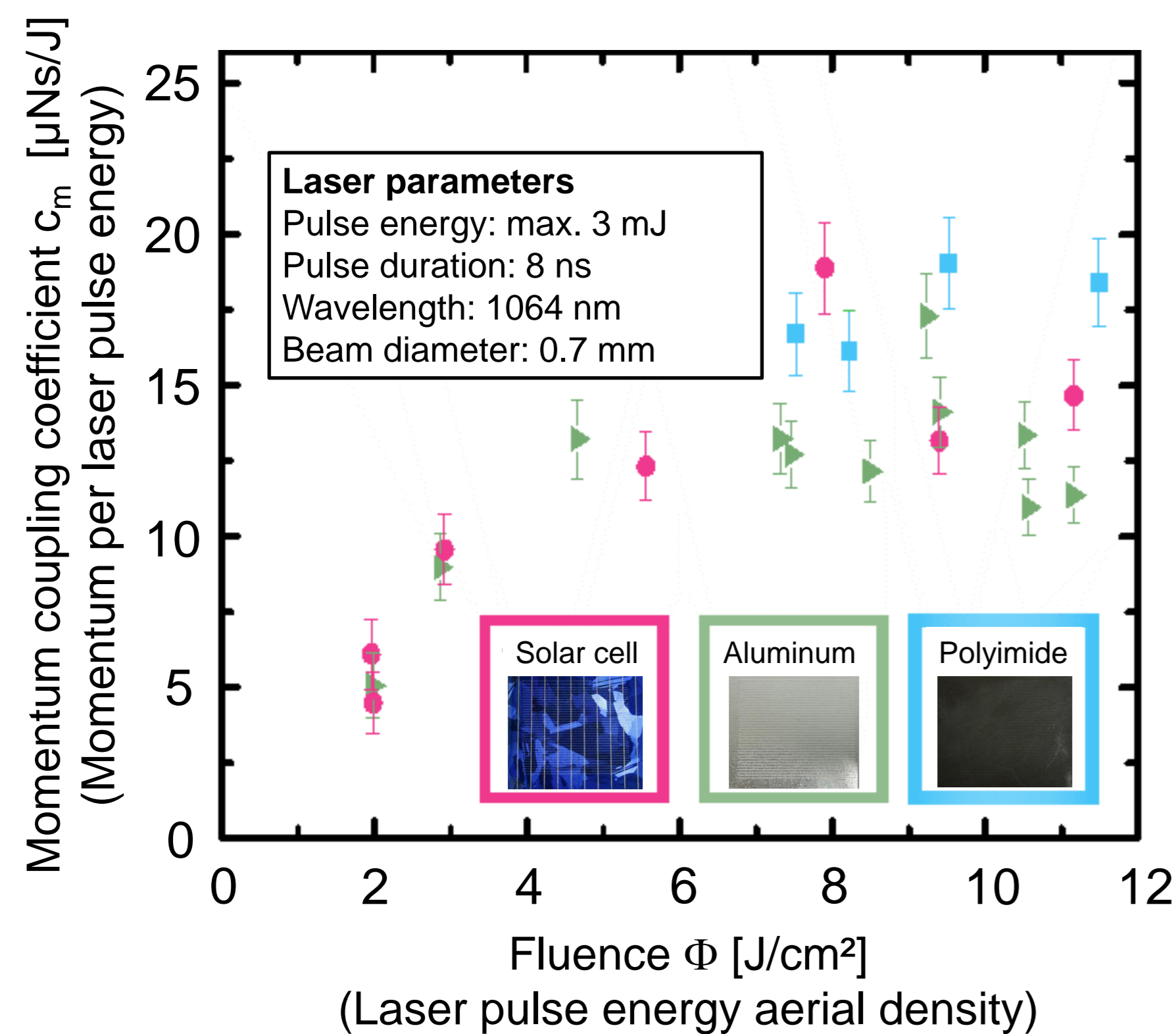

Operational Safety Analysis

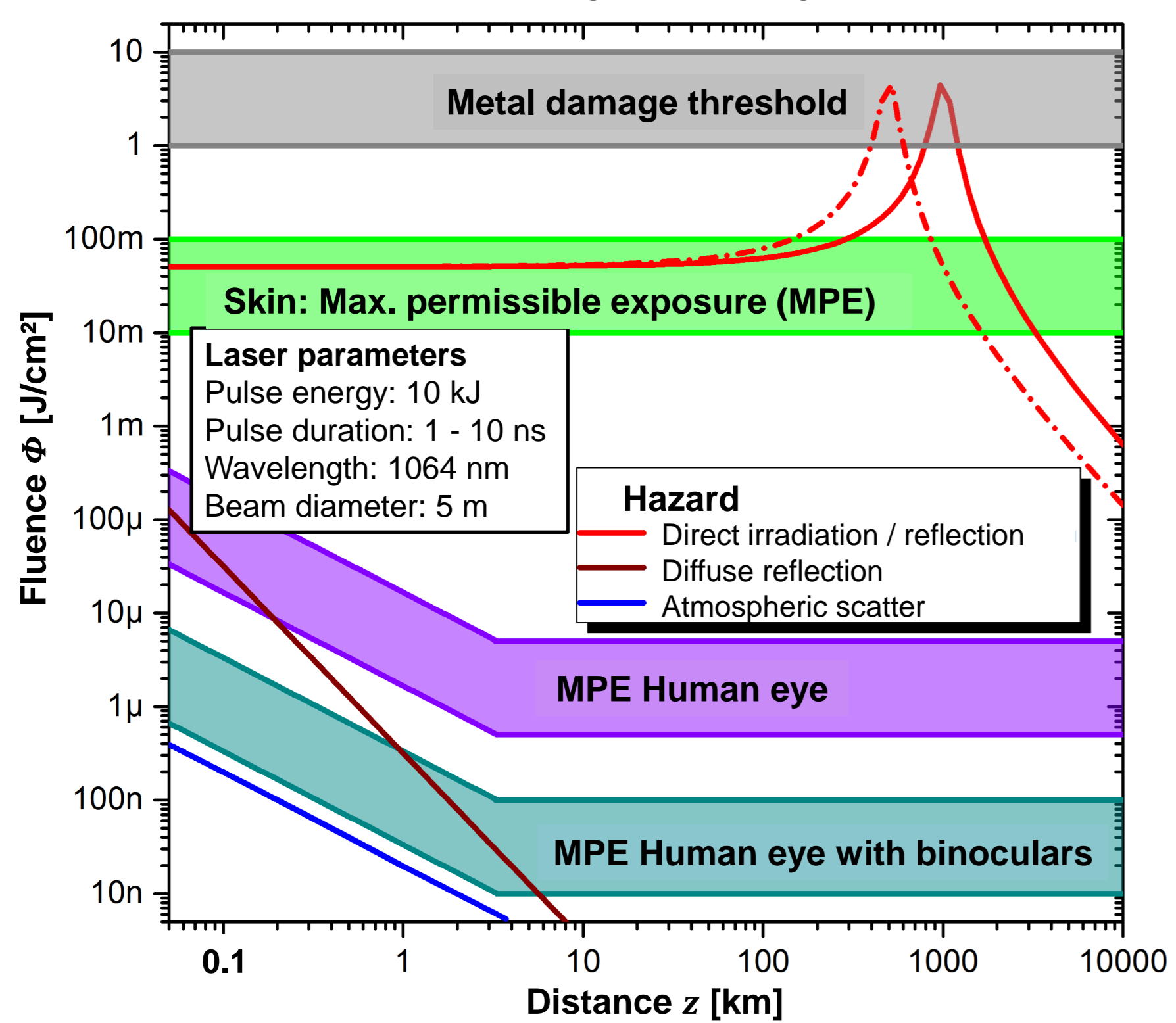

- Local exclusion zone at laser site
- No-fly zone
- Radar control
- Reconciliation with air-traffic control and space agencies

True-Scale Experimental Proof

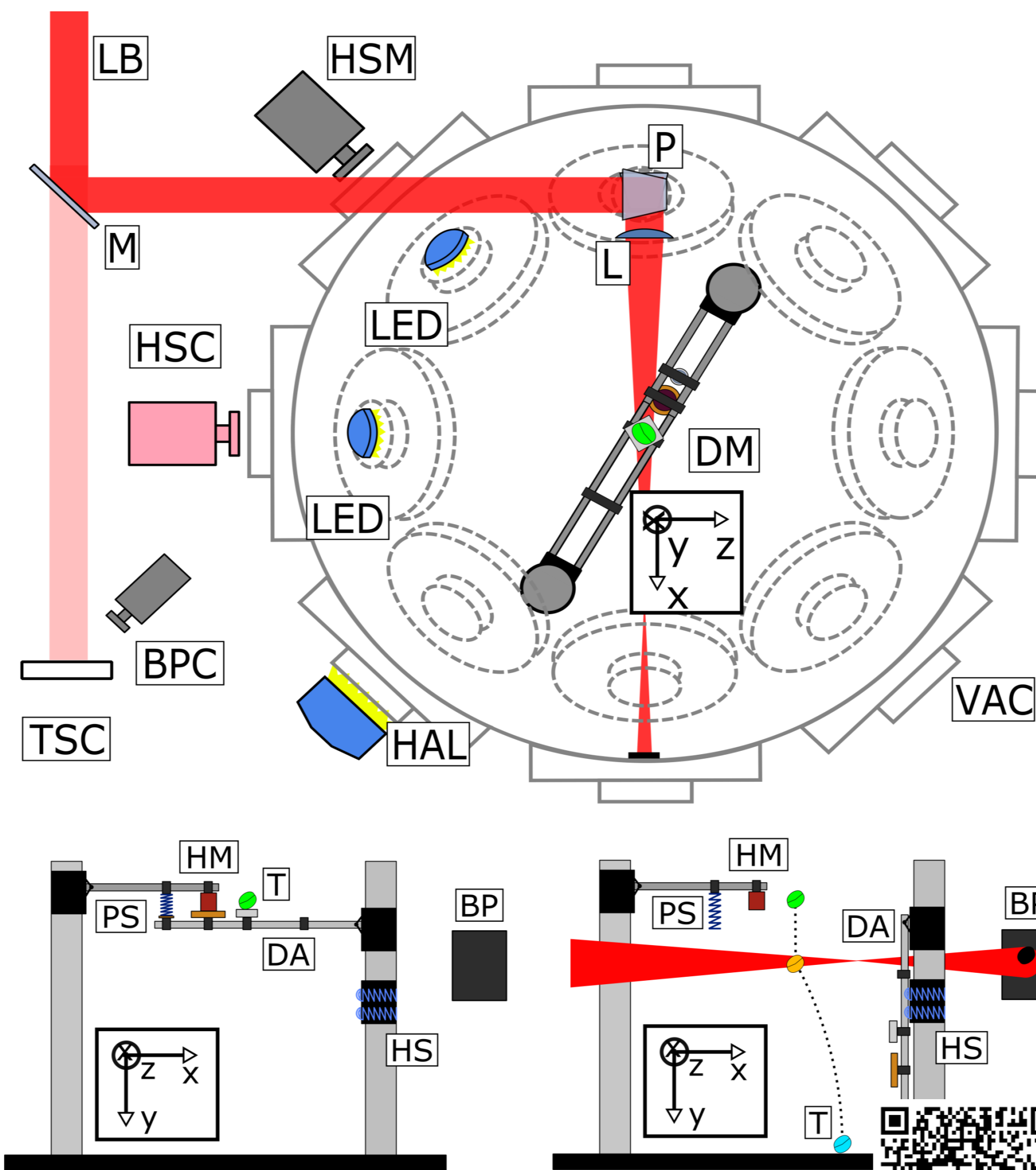

Top: Experimental Setup
Bottom: Dropping mechanism. [Scan here for video](#)
Scientific Reports 2018

Abbreviations:
VAC: vacuum chamber, DM: dropping mechanism, P: periscope, L: Lens, LED: LED-lamp, HAL: halogen lamp, HSM: high-speed camera monochrome, HSC: high-speed camera color, BPC: beam profiling camera, LB: Laser beam, M: mirror, TSC: PTFE screen, HM: holding magnet, T: target, BP: burn pattern foil, PS: pressure spring, DA: dropping arm, HS: holding springs

- cm-sized targets ($\Phi_{target} < \Phi_{spot}$)
- Laser pulse energy: $E_L = 80 J$
- IR laser: $\lambda = 1064 nm, \tau = 10 ns$
- Stereoscopic 3D-tracking, $\Delta t = 1 ms$
- Vacuum ($< 2 Pa$), free fall ($\mu-G$)

Experimental Results

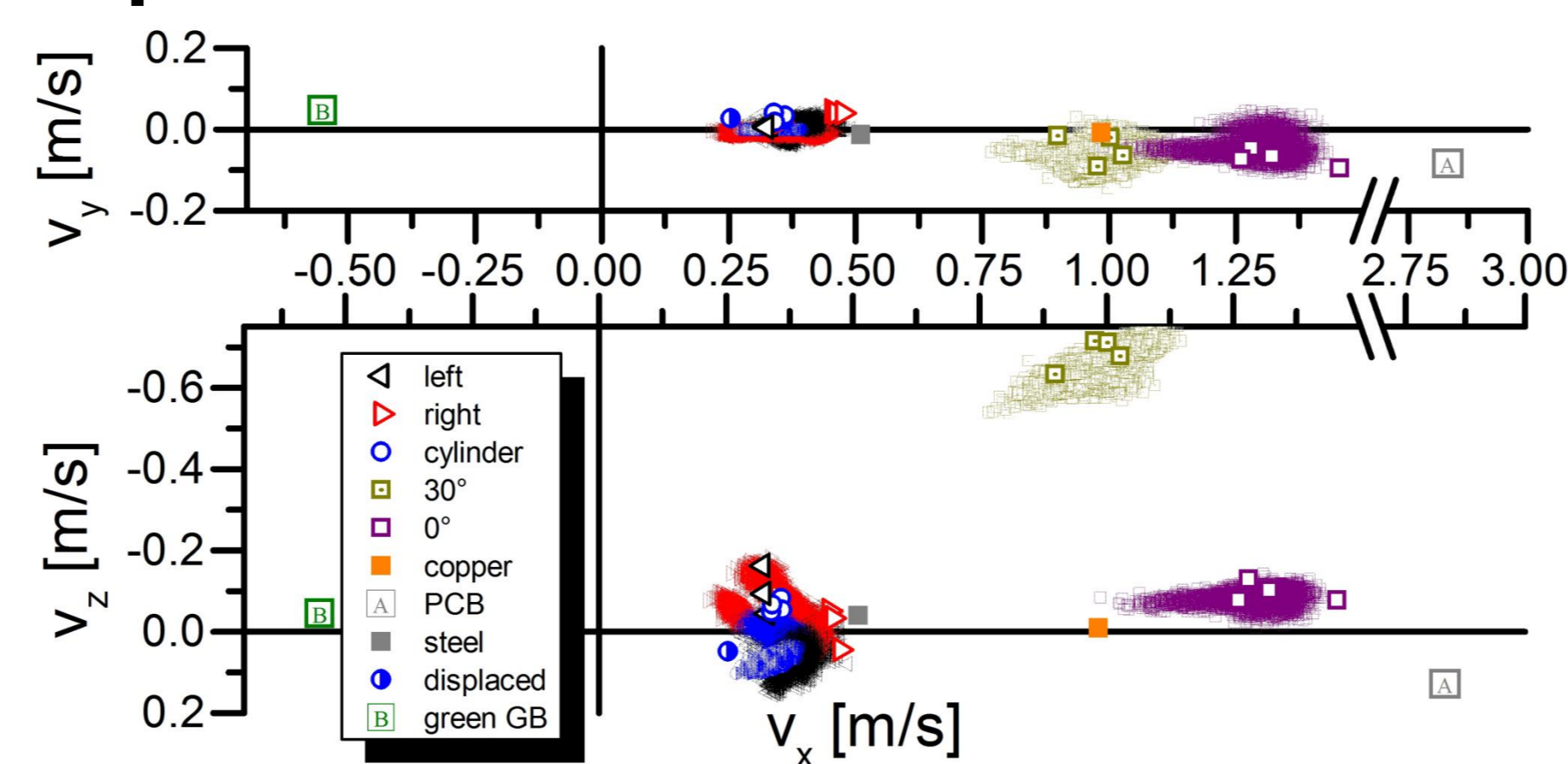

Object velocity changes Δv after laser irradiation. Simulation results are indicated as point clouds.

- Large area to mass \rightarrow high Δv
- 1-pulse $\Delta v \gg 10 cm/s$
- Momentum direction sensitive to target orientation and position

Laser Thermal Removal Simulation

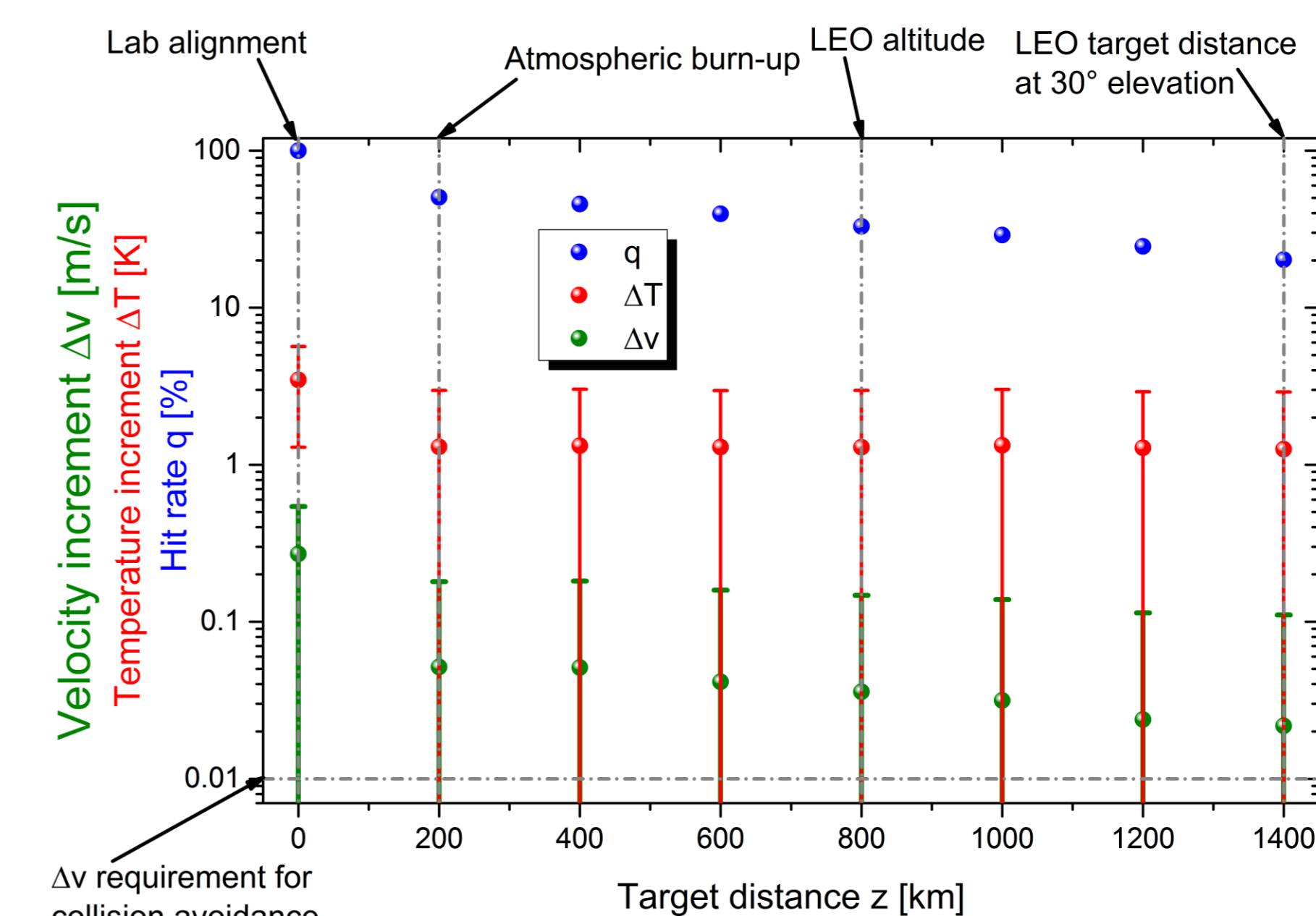

Simulation results for single pulse irradiation:
nHelix laser upscaling: $E_L = 20 kJ, M^2 = 2,$
 $D_{Telescope} = 8 m, Str = 0.4, d_{spot} = 70 cm$
Target: Al plate $2 \times 2 \times 0.1 cm$, arb. orientation
Monte Carlo: $0.42 \mu rad$ pointing, 10000 samples

- Large momentum scatter
- Single pulse collision avoidance

Momentum Predictability and Heat Accumulation
Optical Engineering 2018

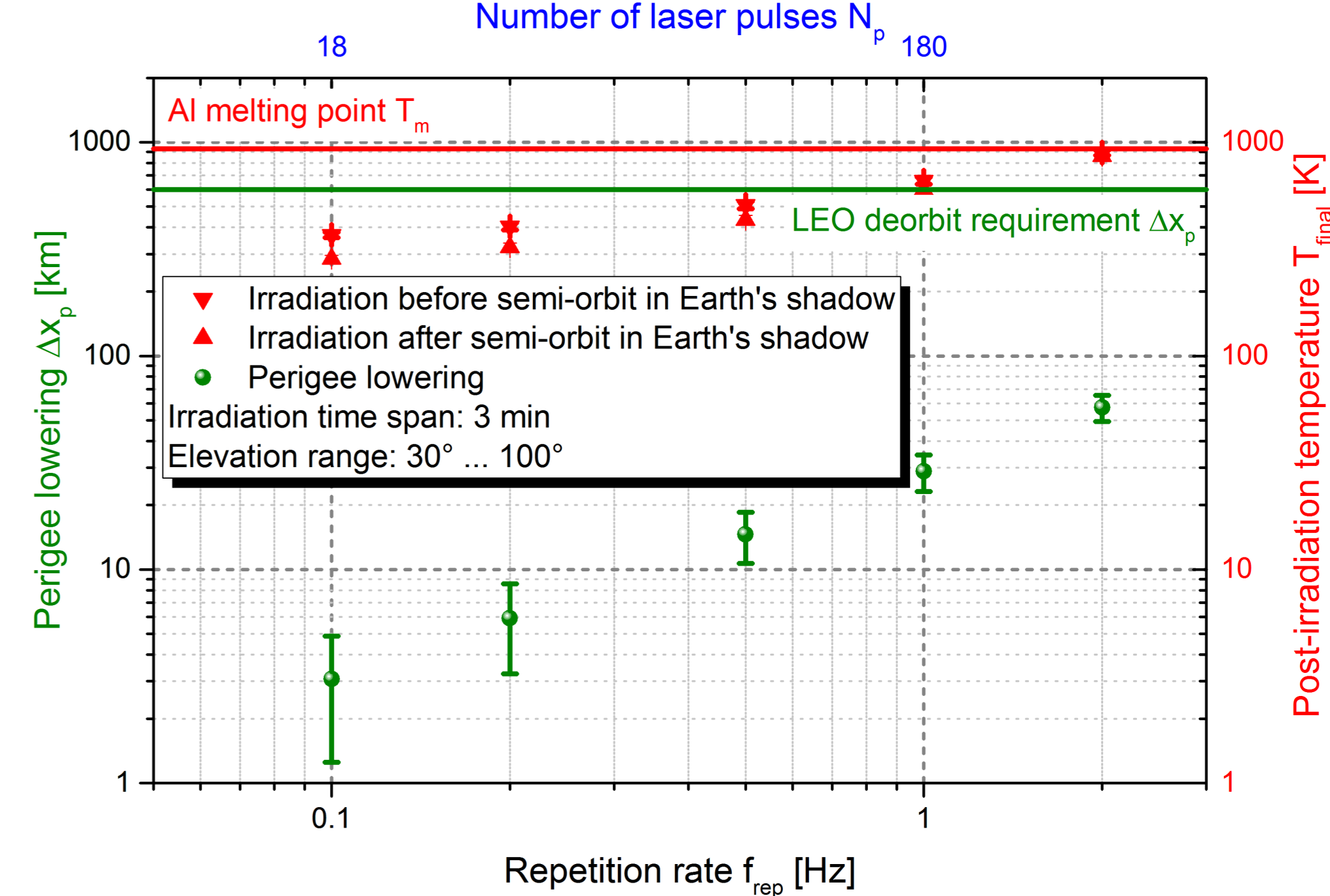

Simulation of multi-pulse irradiation: Parameters as above; supplementary: $T_0 = 327.8 (239.4) K$ (dusk/dawn), $\epsilon = 0.09$, up to 1000 samples each.

- Pulse limitation due to laser heating
- Multi-pass engagements mandatory

Future Research Issues

- Accumulation of heat and stress
- Remote material reconnaissance
- Remote temperature monitoring

